



Puolustusministeriö Försvarsministeriet Ministry of Defence

Expanded Security and Intersectoral Cooperation

First Nordic-American Expert Public Safety Symposium
11-12 October 2006, Copenhagen, Denmark

Juha Martelius

Juha Martelius, Ph.D.

Ministry of Defence:

Director of Research and Development Unit

Previously, i.e.:

Security Police:

Head of Analysis Unit

International Criminal Tribunal for the Former Yugoslavia (ICTY):

Intelligence Analyst

University of Helsinki:

Project Coordinator, International Affairs Coordinator, Lecturer

Finnish Institute of International Affairs:

Researcher

Other:

EU FP 7, Security Research: Head of National Configuration

NATO Committee on Science for Peace and Security: National Representative

The Finnish International Studies Association: Member of Board

Crisis Management Initiative: Member of Programme Working Group



Puolustusministeriö
Försvarsministeriet
Ministry of Defence

2

28.2.2007

Juha Martelius

The Changed Armed Forces Environment

Increase in armed conflicts in the grey area between war and peace

More unpredictable, less controllable, shorter warning period

No clear separation between:
 - internal/ external security
 - military/civilian battle space
 - military/non-military security



Broad spectrum of aggressions:
 direct attack, strategic terrorism,
 urban warfare/guerrilla tactics,
 information warfare, warlords etc.

Increased vulnerability of information societies

Consequence: Change of operational / tactical concepts



Puolustusministeriö
 Försvarsministeriet
 Ministry of Defence

28.2.2007

Juha Martelius

3

Joint Operations in the Past

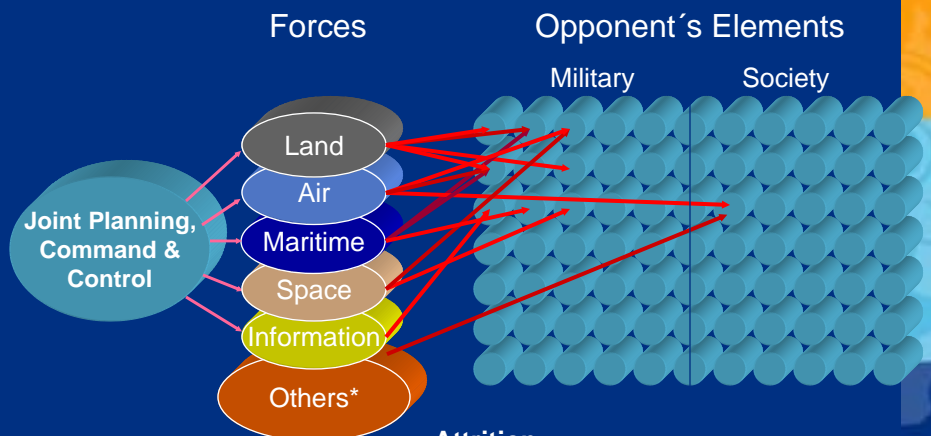

* NGOs, Police etc.

Attrition

- Sequential, Indiscriminate, Collateral Damage...



Puolustusministeriö
 Försvarsministeriet
 Ministry of Defence

28.2.2007

Juha Martelius

4

Joint Operations in the Future

Capability Providers

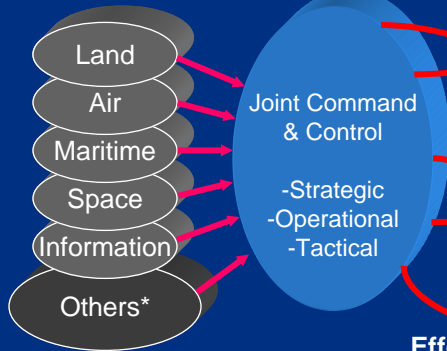

* NGOs, Police etc.

Opponent's Elements

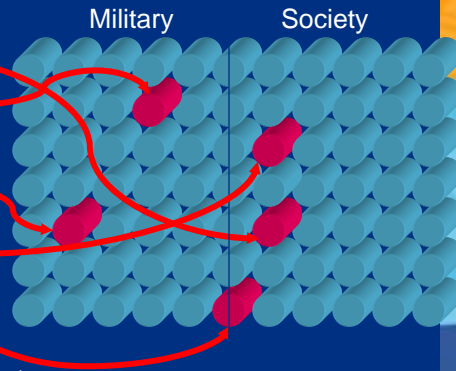

Effects

- Speed, Selective, Precise, Self-Synchronized...
- Defeat Opponent's Elements to Fight War
- Destroy Functions Vital to Society

The Problem of Security

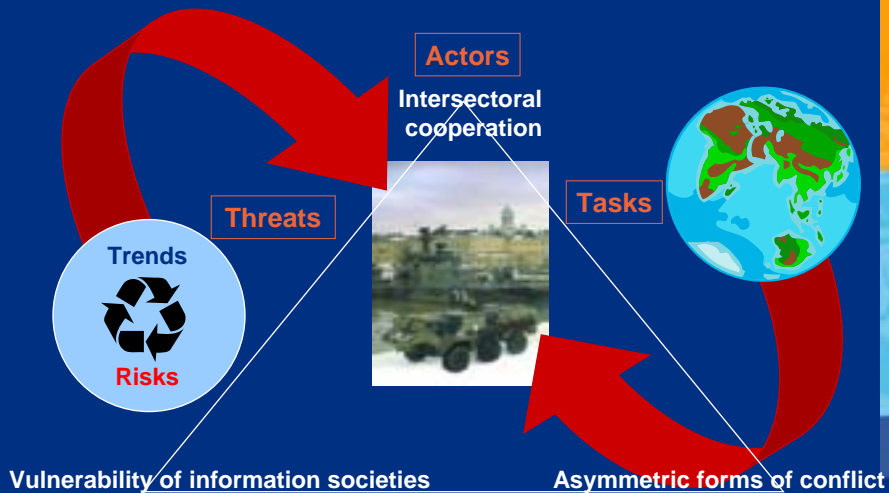

Normal Condition vs. Security Situation

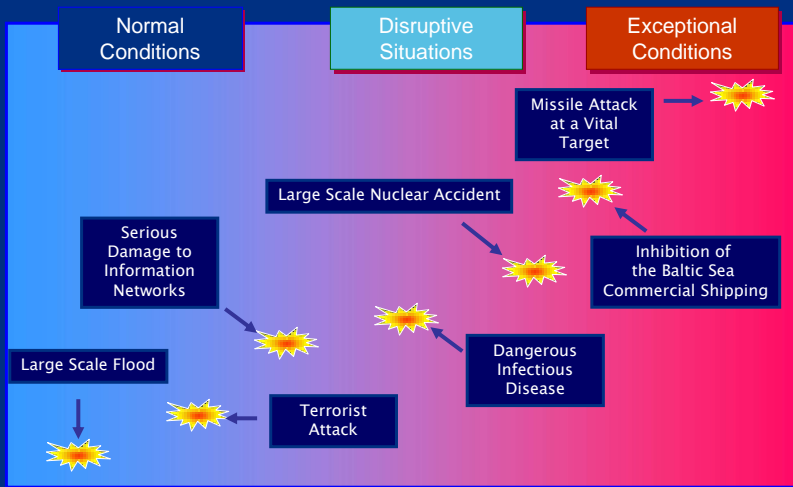

Security Matrix 2/3: Tasks

Aim \ Target	National		Intl	
	National	Intl	Intl	International
State Security	Functioning Judiciary	Counter (War against) Terrorism		Military Defence
Societal Security	Crisis Management	Solidarity Clause		International Crisis Management
Human Security	Law and Order, Rescue	Protection of Citizens		International Catastrophe Aid

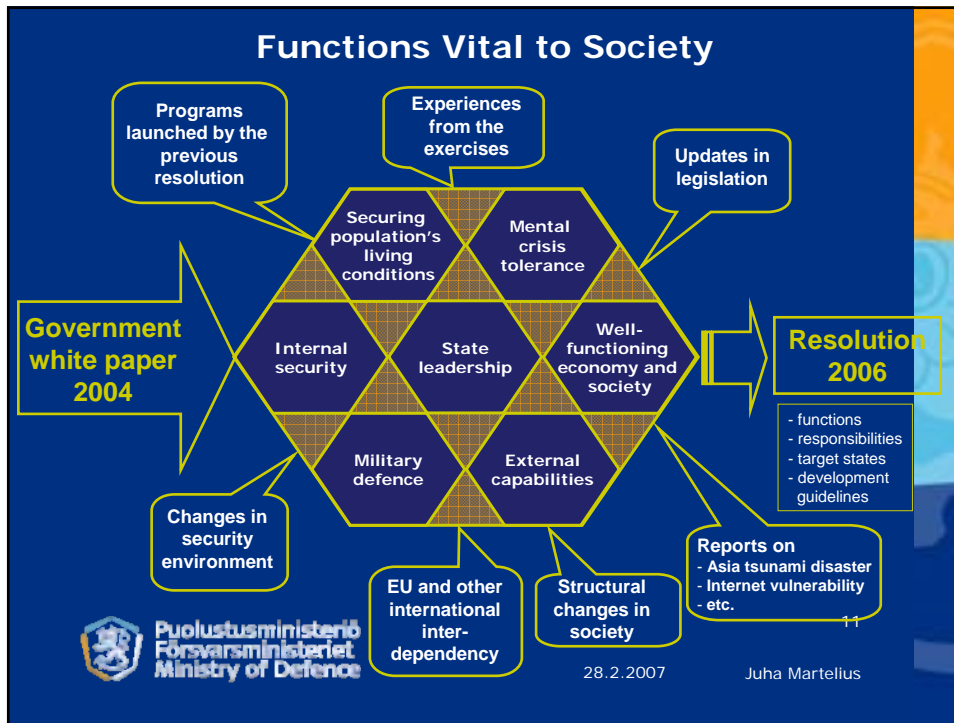

Security Matrix 3/3: Actors

Target	National		Intl	International
Aim	National	National	Intl	International
State Security	Justice, Police	Police, Military, Foreign Service		Military
Societal Security	Police, Rescue	Rescue, Police, Military, Foreign Service		Military, Police, Foreign Service, Rescue
Human Security	Police, Social, Education, NGOs	Rescue, Police, Foreign Service, NGOs		Foreign Service, Police, Rescue, NGOs

Puolustusministeriö
 Försvarsministeriet
 Ministry of Defence

28.2.2007
 Juha Martelius

Interdepartmentality Principle

Ministries: Premier MFA MJ MI MoD MF ME MA MIT MTI MSS ML MEn

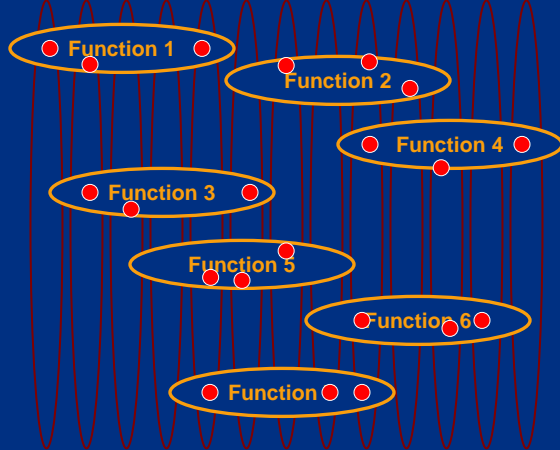

Puolustusministeriö
Försvarsministeriet
Ministry of Defence

● = strategic mission

13

28.2.2007

Juha Martelius

The Process for Developing the Capabilities

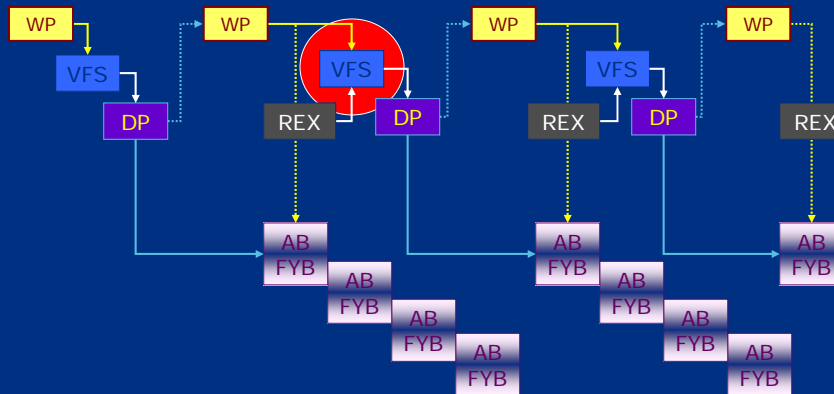

- WP** = Government's white paper on security and defence policy
- VFS** = Strategy for securing the vital functions to society
- AB/FYB** = Annual budget and budget plans for the next four years funding
- DP** = Ministries' development programs
- REX** = Readiness exercise (whole administration)

Challenges

- Decisive role of leadership.
 - Integrated situational awareness.
 - Joint interdepartmental strategy.
 - Cooperation in the era of scarce resources.
 - Are traditional threats to be forgotten? - hardly
 - Not to over securitize – “post 911/tsunami security syndrome”.
 - Resources, budgeting?
 - Prioritization: Focus on intentional/severe threats.
 - Involvement of non-governmental actors.
 - Comprehensive use of private-public partnerships.
 - Evaluation/exercises/evaluation/exercises...
-
- WHAT IS SECURITY ANYWAY...?